





WINNERS ONLY[®]





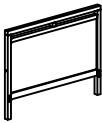
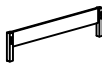

ASSEMBLY INSTRUCTIONS

PROD.NO : BN3001F

Thank you for purchasing this quality product . Please read instructions thoroughly before unpacking assembly parts
 Caution: Sharp, exposed staple tips can cause injury. Therefore, for your protection, please remove any exposed staples used in packing. Please keep all hardware parts out of the reach of children.

1. We recommend that you should assemble this product with the assistance of another person; this will make assembly easier and will help to prevent personal injury and to insure parts are not damaged during assembly process.
2. Before beginning, please check packing materials carefully for small parts that may have come loose inside the carton during shipping. Do not discard any packing material until all parts have been located. If any parts are missing, please contact your dealer for prompt replacement.
3. To prevent damage to your floor or carpet, please check the bottom of each piece of furniture for stain residues and rough surfaces and also check for staples or nails left after removing the packing materials .The manufacturer will not be held responsible if preventive steps are not taken prior to installation.
4. Please do not over tighten screws or bolts. During normal use everyday, screws, bolts , nuts and wooden plugs may loosen up. They should be periodically inspected and re-tightened to prevent damage to the furniture and (or) personal property or cause Always check to be sure all hardware on this list and below mentioned components are attached to the furniture property and kept tightened.
5. Please lay all parts and hardware on a non-abrasive surface such as a carpet and follow the assembly.

Components List : BN-3001FH			
NO.	DESCRIPTION		Q' TY
A		Headboard	1pc
Components List : BN-3001FF			
B		Footboard	1pc
C		Slat Support Legs	5pcs
D		Slat Roll (13pcs)	1Set
Components List : BN-3001FR			
E		Side rail	2pcs

Hardware List				
NO.	DESCRIPTION	SIZE	SKETCH	Q' TY
1	Allen bolt	5/16" * 70mm		8pcs
2	Half moon washer	Ø5/16"		8pcs
3	Spring Washers	8mm		8pcs
4	Hexagon	Ø5/16"*12mm		8pcs
5	Wrench	12mm		1pc
6	Wood Screw	#8 *32mm		6pcs

IMPORTANT NOTE:
 - Please do not over tighten screws or bolts
 - Please keep all hardware parts out of the reach of children
 - Two or more people are needed for assembly

TIP: Store the Allen key and Wrench in assembly in this product drawer or use masking or painter tape to affix it to the underside of the product. This will make it easier to find if you want to periodically tighten bolts or disassemble the product.

WINNERS ONLY[®]

ASSEMBLY INSTRUCTIONS

PROD.NO : BN3001F

STEP 1: Attach both Bed Rails (E) to the Headboard (A) and footboard (B) using the provided hardware as shown on FIG.1

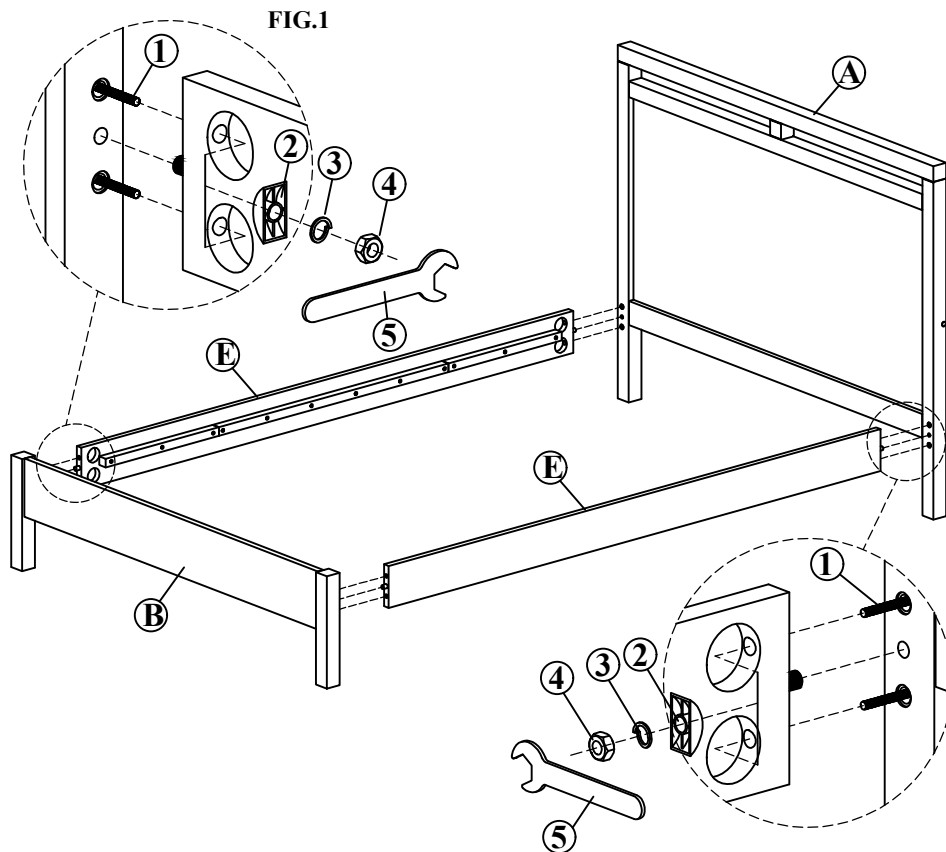

STEP 2 : Attach Slats Support Legs (C) to the Slats (D) as shown on FIG.2

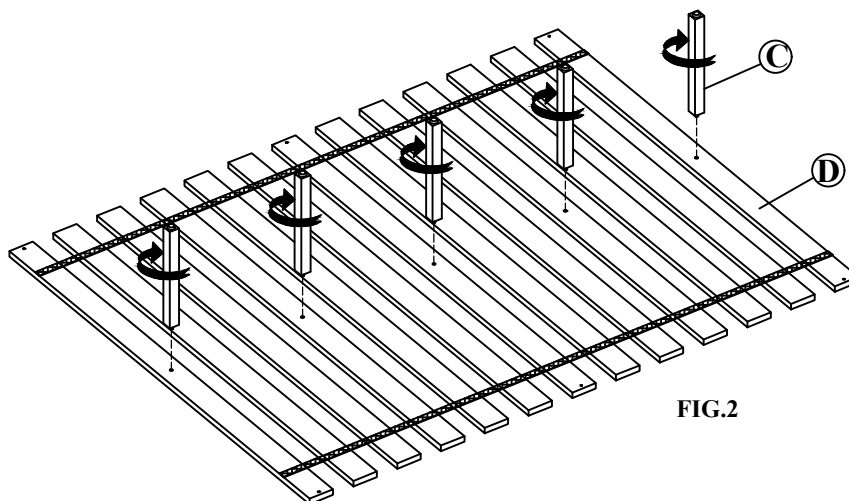

WINNERS ONLY[®]

ASSEMBLY INSTRUCTIONS

PROD.NO : BN3001F

STEP 3: Attach the Slats Roll (D) to the Side Rails (E) using provided hardware as shown in FIG.3

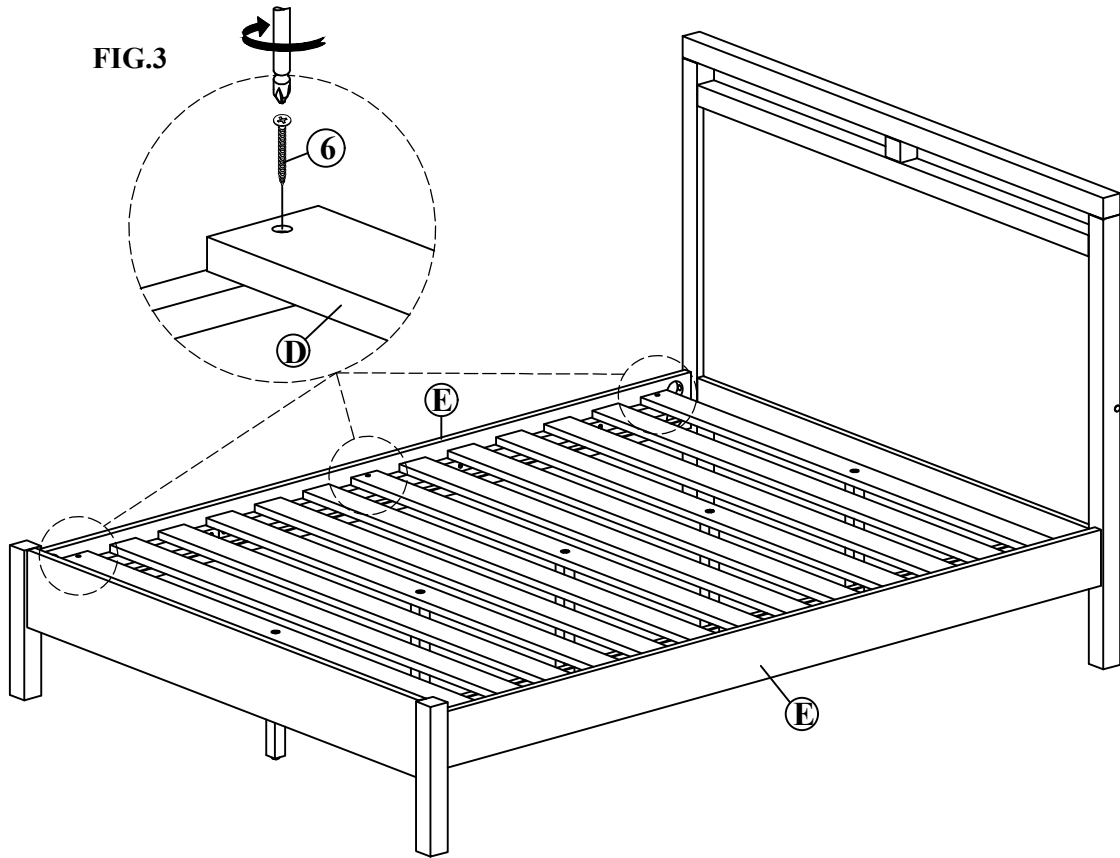

Assembly is now completed.

